

FEATURES

- Additional 20kA & 20kV Surge Protector as standard
- High protection level up to IP66
- High impact resistance, meeting IK10
- Low EPA design, anti 17-level wind power
- High vibration resistance, meeting 3G standards
- Aluminum powder coated fixture
- 304 stainless steel mounting brackets and hardwares
- LED Lifespan: 50,000 hours
- Warranty: 5-year limited











ACCESSORIES

- Visor
- Laser Aiming Device
- Glare Control Shield

APPLICATIONS

- Sport Fields
- Stadiums
- Entrance & Roadway
- Industrial Facilities
- Airports
- Shipping Docks

SPECIFICATIONS

Product Pictures										
Model No.	7H240LIMD	7H320LIMD	7H400LIMD	7H500LIMD	7H600LIMD	7H750LIMD	7H960LIMD	7H965LIMD	7H1200LIMD	7H1440LIMD
Power	240W	320W	400W	500W	600W	750W	960W	965W	1200W	1440W
Lumen Range	36,720 LM	48,960 LM	60,800 LM	75,500 LM	91,200 LM	113,250 LM	136,320 LM	141,855 LM	177,600 LM	204,480 LM
Efficacy Range	153 LM/W	153 LM/W	152 LM/W	151 LM/W	152 LM/W	151 LM/W	138 LM/W	147 LM/W	144 LM/W	138 LM/W
Voltage	100-277V or 100-240V	100-277V or 100-240V	100-277V or 100-240V	100-277V or 100-240V	100-277V or 100-240V	100-277V or 100-240V	100-277V or 100-240V	100-277V or 100-240V	100-277V or 100-240V	100-277V or 100-240V
Driver Brand	Mean Well	Mean Well	Mean Well	Mean Well	Mean Well	Mean Well	Mean Well	Mean Well	Mean Well	Mean Well
Dimmable	0-10V Dimming	0-10V Dimming	0-10V Dimming	0-10V Dimming	0-10V Dimming	0-10V Dimming	0-10V Dimming	0-10V Dimming	0-10V Dimming	0-10V Dimming
Beam Angle	20°/40°/60°/90°	20°/40°/60°/90°	20°/40°/60°/90°	20°/40°/60°/90°	21°/30°/40°/60°	21°/30°/40°/60°	21°/30°/40°/60°	21°/30°/40°/60°	21°/30°/40°/60°	21°/30°/40°/60°
Color Temp.	40K/50K/57K	40K/50K/57K	40K/50K/57K	40K/50K/57K	40K/50K/57K	40K/50K/57K	40K/50K/57K	40K/50K/57K	40K/50K/57K	40K/50K/57K
CRI	70	70	70	70	70	70	70	70	70	70
SPD	20kA/20kV	20kA/20kV	20kA/20kV	20kA/20kV	20kA/20kV	20kA/20kV	20kA/20kV	20kA/20kV	20kA/20kV	20kA/20kV
Fixture Color	Bronze	Bronze	Bronze	Bronze	Bronze	Bronze	Bronze	Bronze	Bronze	Bronze
IP Rating	IP66	IP66	IP66	IP66	IP66	IP66	IP66	IP66	IP66	IP66
Operating Temp.	-40°C to +40°C	-40°C to +40°C	-40°C to +40°C	-40°C to +40°C	-40°C to +40°C	-40°C to +40°C	-40°C to +40°C	-40°C to +40°C	-40°C to +40°C	-40°C to +40°C
Average Lifespan	50,000 hours	50,000 hours	50,000 hours	50,000 hours	50,000 hours	50,000 hours	50,000 hours	50,000 hours	50,000 hours	50,000 hours
Compliance	DLC / cULus / CE Pending									
Warranty	5-year limited									

**Product performance may vary depending on model and end user environment.*

Due to our continued efforts to improve our products, product specifications are subject to change without notice.

Phone: 86-755-8340-5100 | Fax: 86-755-8224-7517 | Add: Shenzhen, China

For more information please visit our website: www.greeninova.com

RELEASE DATE: 8/8/2023

DIMENSIONS

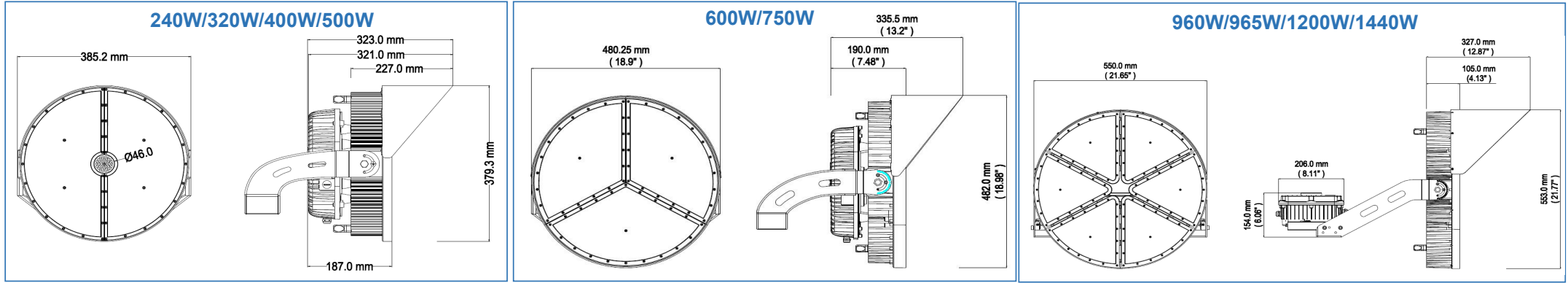

ORDERING INFORMATION

Order Example: 7H500LIMD2350BRTVR7= 500W, 100-277V, Integral System, Mean Well LED Driver, Dimming, 20°, Seoul Semiconductor LEDs, 5000K, Bronze, 20kA SPD, with Visor, CRI70

7H	500	L	I	M	D	2	3	50	BR	T	V	R7
Series	Wattage	Voltage	Driver System	Driver Brand	Dimming	Beam	LEDs Brand	CCT	Finish	SPD	Options	CRI
7H= Gen.7 New Generation LED Sports Light / LED High-Mast Light	240= 240W 320= 320W 400= 400W 500= 500W 600= 600W 750= 750W 960= 960W 965= 965W 1200= 1200W 1440= 1440W	L= 100-277V L1= 100-240V L2= 120V	I= Integral System	M= Mean Well	D= Dimming(Std.) Blank= Non-Dim	2= 20° 3= 30° 4= 40° 6= 60°	3= Seoul Semiconductor	40= 4000K 50= 5000K 57= 5700K	BR= Bronze(Std.) WH= White BK= Black	T= 20kA(Std.) 0= 10kA Blank= Non-SPD	E= Zigbee X= DMX Blank=None P= Photocell sensor Blank=None V= Visor Blank=None G= Glare Control Shield Blank=None	R7= CRI70(Std.) R8= CRI80 R9= CRI90